

3 72 793 D

DOUBLE DIN FITTING KIT

BMW 5 Series (E60) 2003 - 2007

(For Non LCI Models Only)

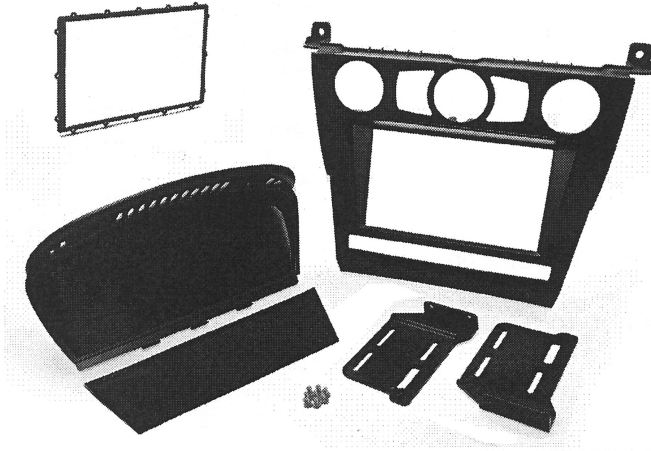

Tools Required:

- Panel Removal Tool/s
- Screwdriver/s

DISCLAIMER

This instruction booklet is based on carefully documented data and research. Connects2 cannot be held responsible for discrepancies/inconsistencies that may occur due to automobile manufacturing changes, options, or damage that may occur in the vehicle during the installation of components while using this booklet

Need help with your installation? Visit support.connects2.com

STEP ONE

OEM Head Unit:

BMW 5 Series (E60) [Non LCI]

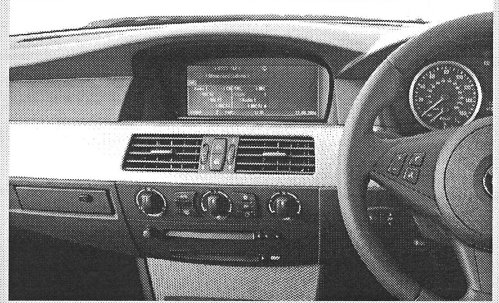

STEP TWO

Using a panel removal tool, pry away the air vent trim from the dashboard.

Once removed, disconnect wiring from the air vents and move the air vent/trim assembly to a safe location

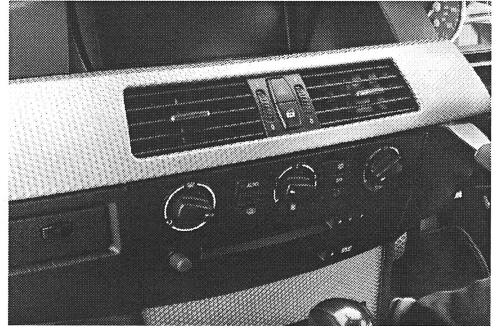

STEP THREE

Use a screwdriver to remove the two screws from either side of the climate control panel, underneath the air vents, as shown in the image (circled)

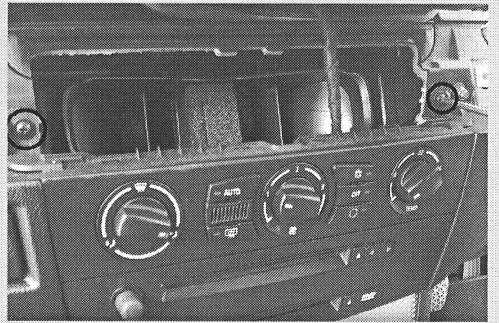

STEP FOUR

Use a panel removal tool to pry away the main fascia panel from the dashboard

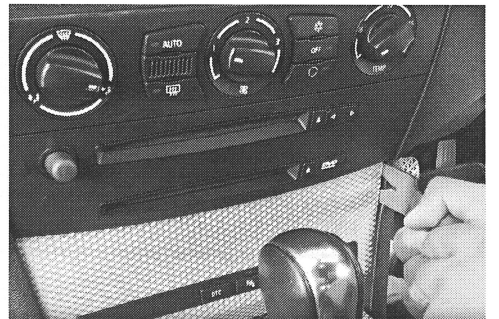

STEP FIVE

Remove the climate control panel and unplug the two connections to the climate controls (circled).

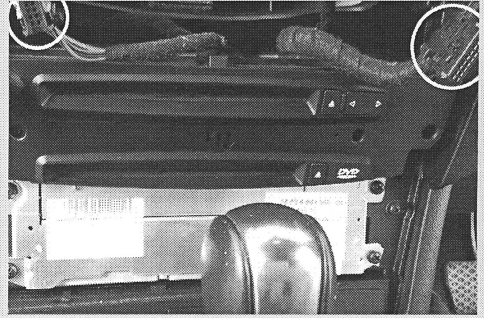

STEP SIX

Once the climate control panel has been removed, use a screwdriver to remove the four screws holding the OEM head unit in place.

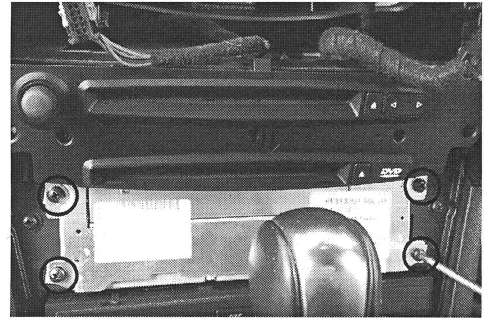

STEP SEVEN

Remove the OEM head unit and disconnect all wiring to the unit.

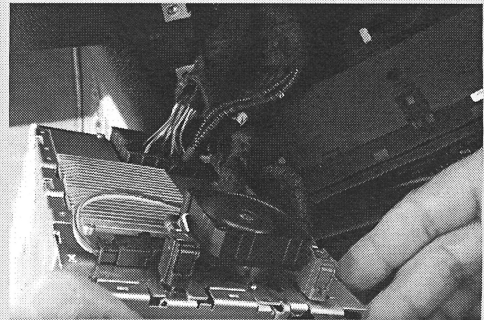

STEP EIGHT

Use a screwdriver to remove the two screws at the locations shown by the arrows. Use a panel removal tool to remove the OEM display screen.

Disconnect all wiring to the screen.

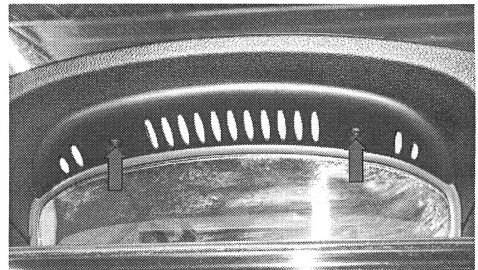

STEP NINE

To begin kit assembly, attach the two brackets (2,3) to the new head unit using the eight screws provided and push the head unit/bracket assembly into the dash. Make all connections to the head unit before proceeding

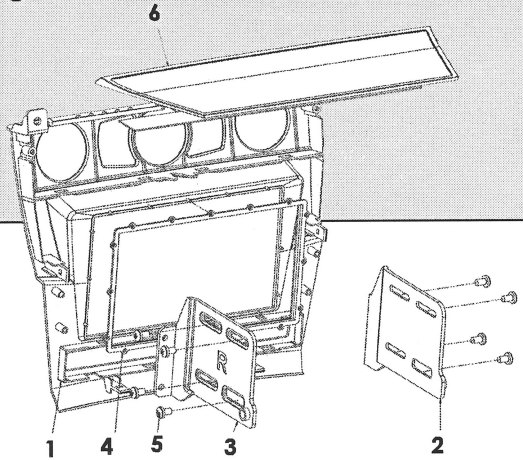

STEP TEN

Fit the trim piece (4) onto the back of the CT23BM14 fascia panel (1) and push the fascia panel into the dash, surrounding the aftermarket head unit.

STEP ELEVEN

Reassemble the air vents, climate controls and trim panels in reverse order of disassembly.

Push the display blanking panel into the gap left by the OEM display.

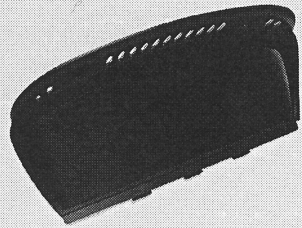

STEP TWELVE

Finally, use a strip of double sided adhesive and attach one side to the rubber mat. Then attach the rubber mat to the shelf on the bottom edge of the display to complete your installation

